

## CDBUC0230-HF

High-Reliability and High-Performance

$I_o = 200\text{mA}$

$V_R = 30\text{VmA}$

RoHS Device

Halogen Free

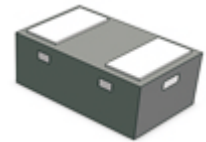

### Features

- Designed for mounting on small surface.
- Extremely thin/leadless package.
- Low drop-down voltage.
- Majority carrier conduction.

### Mechanical data

- Case: 0603C/SOD-523F standard package, molded plastic.
- Terminals: Matte tin plated, solderable per MIL-STD-750, method 2026
- Polarity: Indicated by cathode band.
- Mounting position: Any
- Weight: 0.003 grams (approx.).

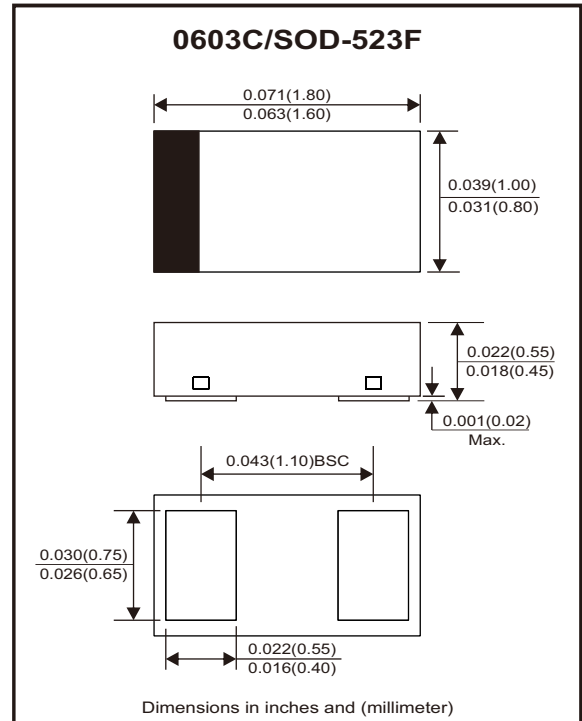

### Circuit Diagram



### Maximum Rating (at $T_A=25^\circ\text{C}$ unless otherwise noted)

Parameter	Conditions	Symbol	Min	Typ	Max	Unit
Repetitive peak reverse voltage		$V_{RRM}$			35	V
Reverse voltage		$V_R$			30	V
Average forward current		$I_o$			200	mA
Peak forward surge current	8.3 ms single half sine-wave superimposed on rate load (JEDEC method)	$I_{FSM}$		3000		mA
Power dissipation		$P_D$			150	mW
Junction temperature range		$T_j$	-40		+125	$^\circ\text{C}$
Storage temperature range		$T_{STG}$	-40		+125	$^\circ\text{C}$

### Electrical Characteristics (at $T_A=25^\circ\text{C}$ unless otherwise noted)

Parameter	Conditions	Symbol	Min	Typ	Max	Unit
Forward voltage	$I_F = 200\text{ mA DC}$	$V_F$			0.50	V
Reverse current	$V_R = 30\text{V}$	$I_R$			30	$\mu\text{A}$
Capacitance between terminals	$F = 1\text{MHz}$ and 10V DC reverse voltage	$C_T$		9		pF

## Rating and Characteristic Curves (CDBUC0230-HF)

Fig.1 - Forward Characteristics

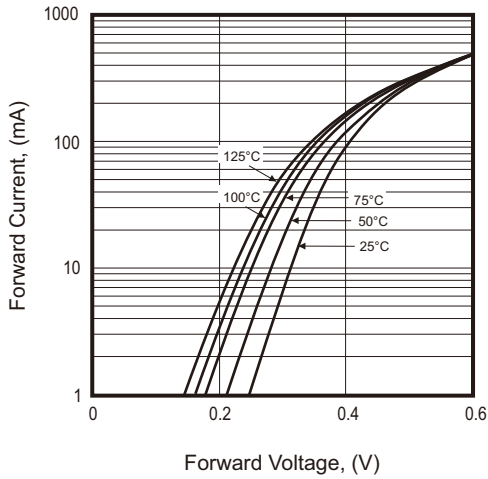

Fig.2 - Reverse Characteristics

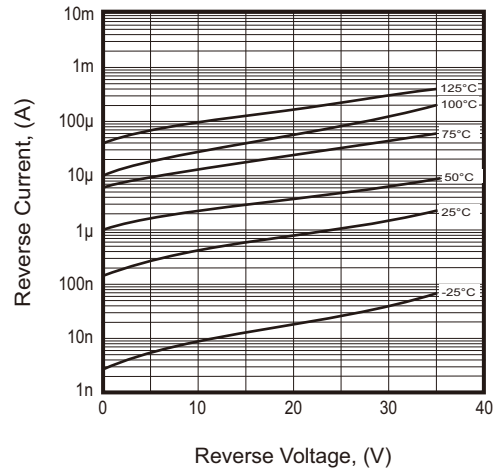

Fig.3 - Capacitance Between Terminals Characteristics

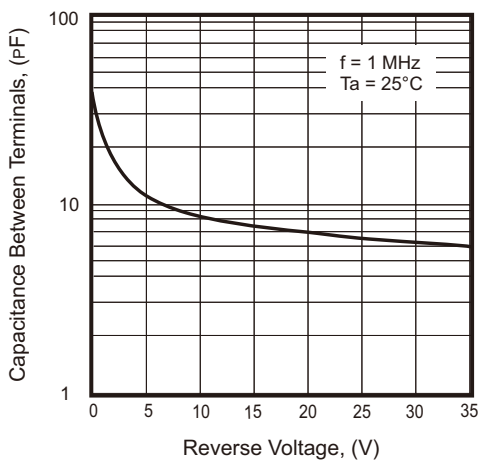
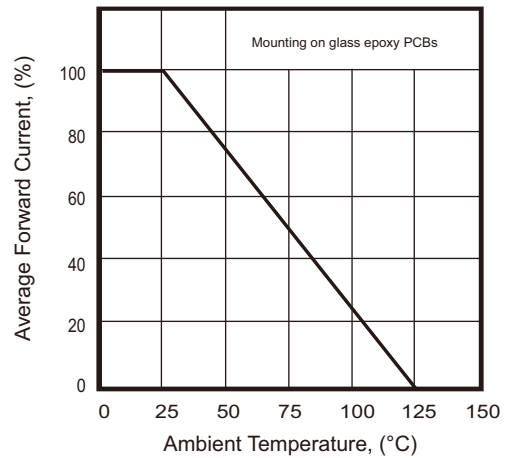
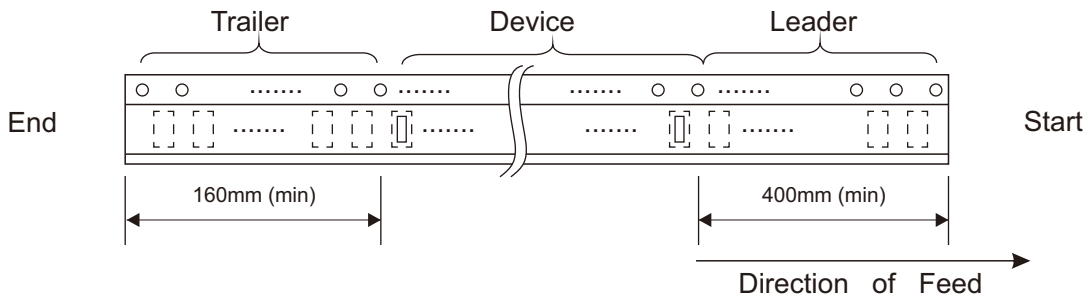
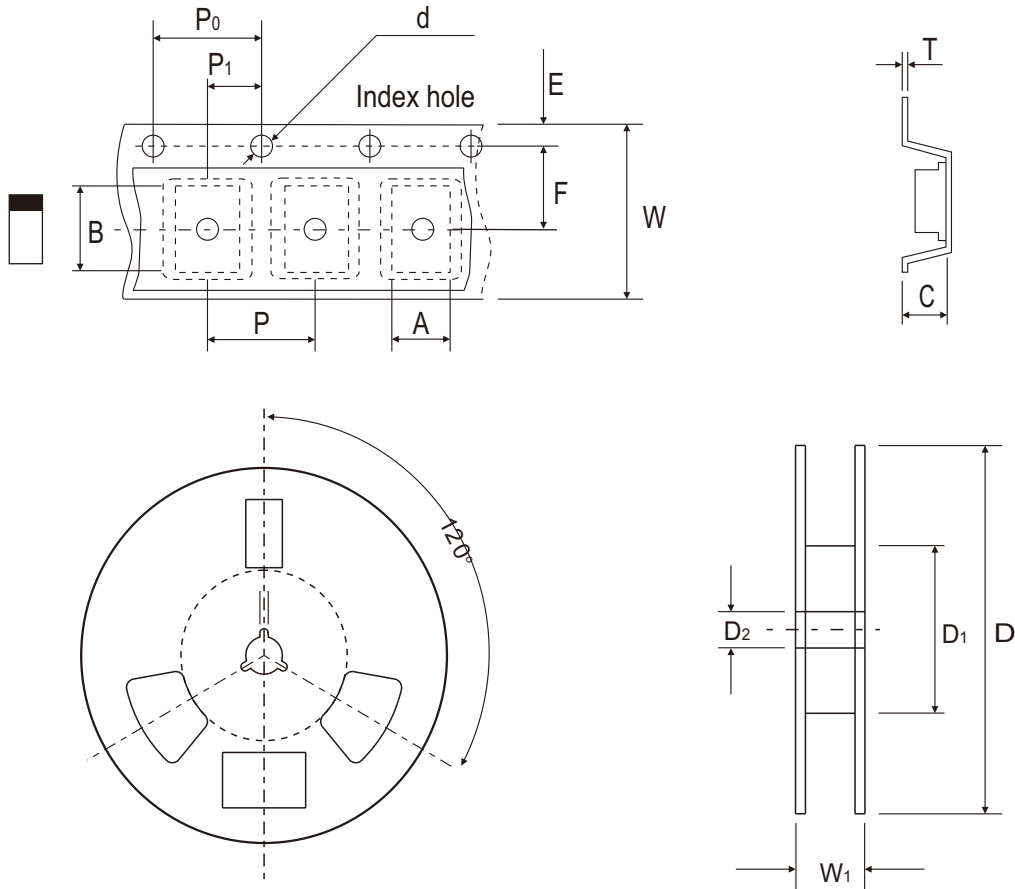

Fig.4 - Current Derating Curve



## Reel Taping Specification



0603C/ SOD-523F	SYMBOL	A	B	C	d	D	D <sub>1</sub>	D <sub>2</sub>
	(mm)	1.05 ± 0.05	1.96 ± 0.05	0.57 ± 0.05	1.50 + 0.10 - 0	178.00 ± 1.00	60.00 ± 0.50	13.50 ± 0.20
	(inch)	0.041 ± 0.002	0.077 ± 0.002	0.022 ± 0.002	0.059 + 0.004 - 0	7.008 ± 0.039	2.362 ± 0.020	0.531 ± 0.008

0603C/ SOD-523F	SYMBOL	E	F	P	P <sub>0</sub>	P <sub>1</sub>	T	W	W <sub>1</sub>
	(mm)	1.75 ± 0.10	3.50 ± 0.05	4.00 ± 0.10	4.00 ± 0.05	2.00 ± 0.05	0.20 ± 0.03	8.00 ± 0.20	12.00 + 0.50 - 0
	(inch)	0.069 ± 0.004	0.138 ± 0.002	0.157 ± 0.004	0.157 ± 0.002	0.079 ± 0.002	0.008 ± 0.001	0.315 ± 0.008	0.472 + 0.020 - 0

## Marking Code

Part Number	Marking Code
CDBUC0230-HF	B5



## Suggested PAD Layout

SIZE	0603C/SOD-523F	
	(mm)	(inch)
A	1.10	0.043
B	0.70	0.028
C	1.00	0.039
D	1.80	0.071
E	0.40	0.016

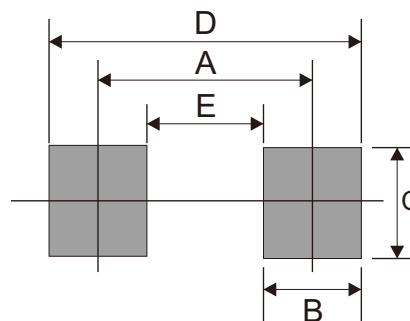

## Standard Packaging

Case Type	REEL PACK	
	REEL ( pcs )	Reel Size (inch)
0603C/SOD-523F	4,000	7